

TERA[®] CONTRACT

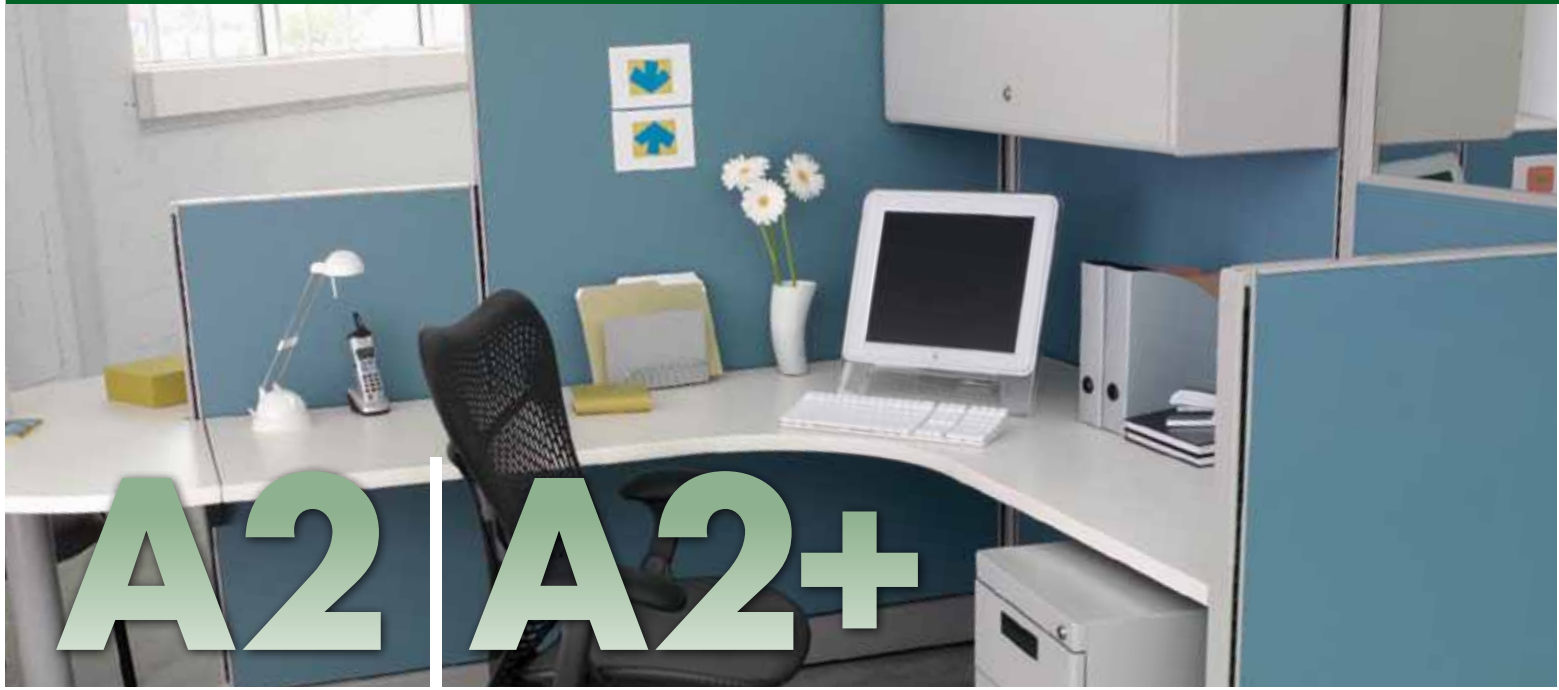

Office System Solutions handled from design through installation to create a successful office environment



A2 & A2+ enable the customer to design work stations using a variety of panel heights and work surface shapes allow for privacy or to enhance team work.



A2 & A2+ is standard with a molded base in many color options. The base design protects the panel system from kicking and vacuum damage over time while allowing for significant electrical and data wiring capacity.



A2 & A2+ offers many overhead storage designs including fabric covered, painted fronts, various profiles, and either recessed or over-the-top covers.



A2 & A2+ offers storage of many functional types and in many color options. Stationary storage to mobile systems, box drawers, vertical and horizontal filing drawers, shelving, wardrobe storage...the combinations are endless.



A2 4-pod



A2

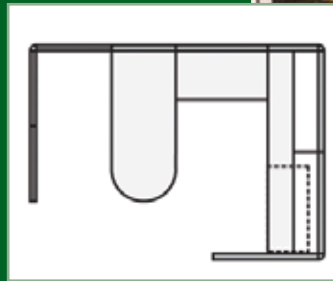
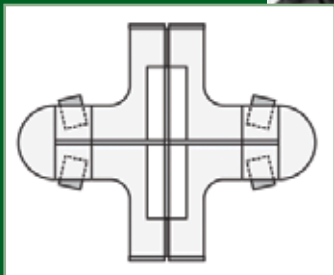



PFT tiles are available fabric covered with tackable and acoustical properties. Faux wood grain top caps and end caps are a perfect way to dress up your workstation design.



PFT top and end caps in a textured plastic material outline the workstations beautifully and maintain the value price you will enjoy. Customers may also elect to use our radius aluminum top caps to upgrade your overall design.



PFT starts with a robust frame that is 3.25" thick, 14 gauge steel and welded for strength. Wire management is possible everywhere both vertically and horizontally. Connections between frames are steel blocks and simplified using nuts and bolts to make a solid connection.



PFT may be designed for a floor-to-ceiling application to eliminate building modifications while giving you mosaic tile finish choices including glass, frosted glass, fabric, airflows, white board, and laminate. Design, installation, and price have been made easy and affordable with the PFT system.

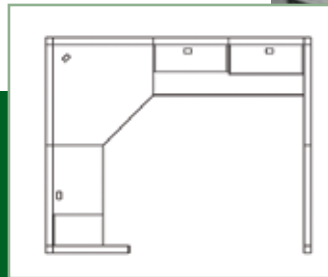

PFT

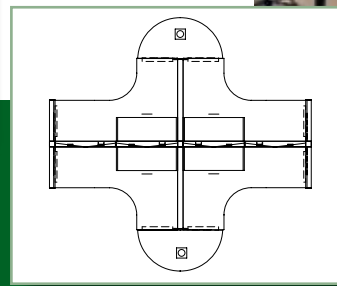

PFT 4-pod

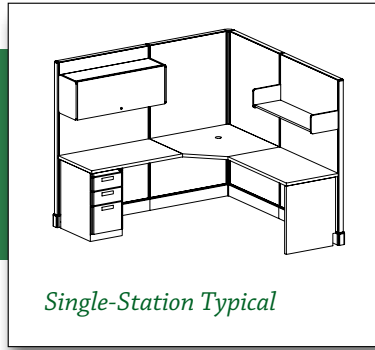

Single-Station Typical

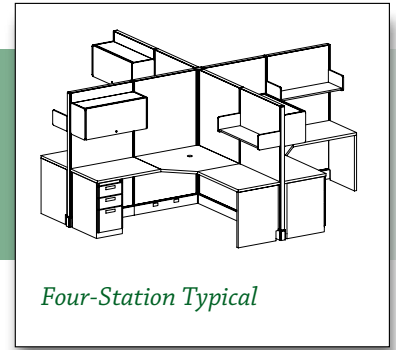

Four-Station Typical

A2

Couple the benefits of Grade A panel system quality with the exceptional pricing, service, and support from TERA[®]. Select from a wide variety of fabrics, finishes, and laminates to create an environment that offers aesthetics and privacy.



A2+

Enhance your TERA[®] A2 environment with a tiled-look. By incorporating one or many A2+ panels in an environment, TERA[®] customers can join value and unique design options into a beneficial panel system environment.



PFT

PFT systems offers enhanced wire management, a wider panel thickness for design and stability, and an ability to individually create a dressed-up environment using fabric, laminate, white board, glass, and/or painted tiles throughout a work station.



Statement of Line

PFT Frames & Panels

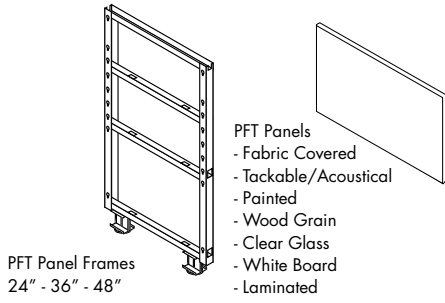

A2 Panels

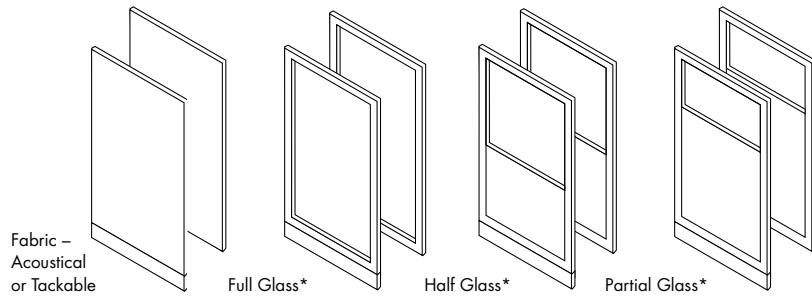

Worksurfaces

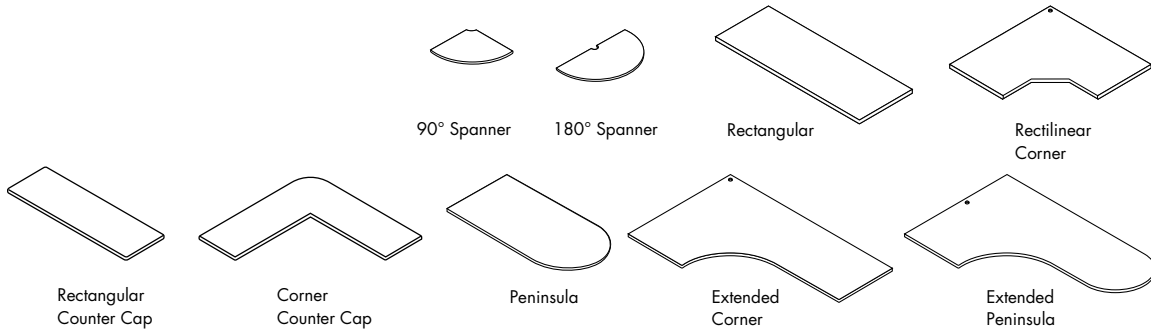

Worksurface Supports

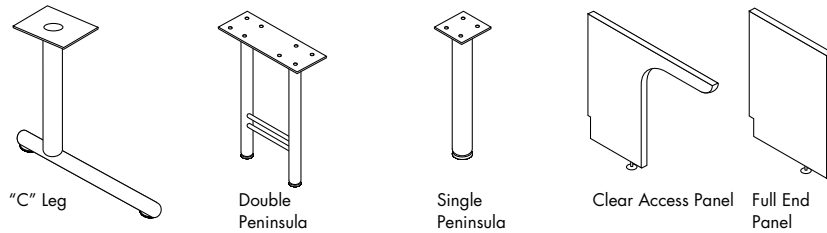

Overhead Storage

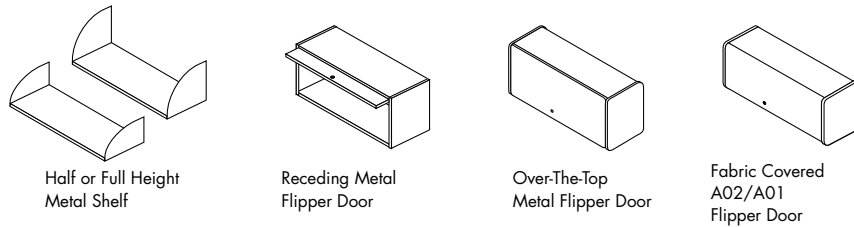

File Centers

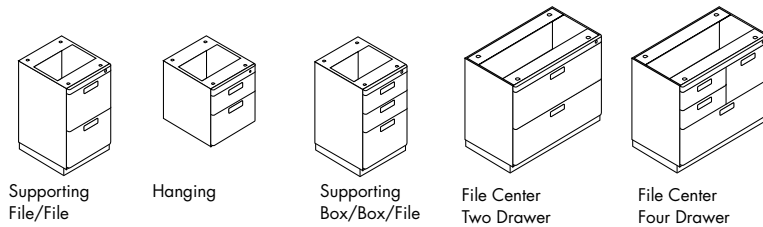

Storage Towers

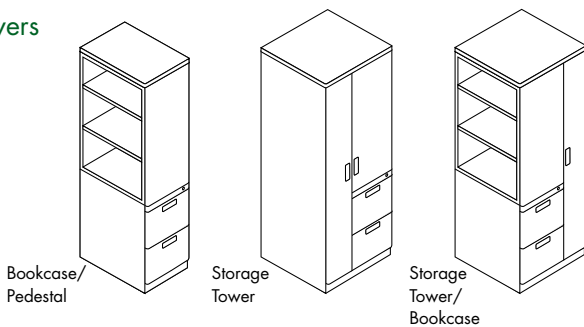

Accessories

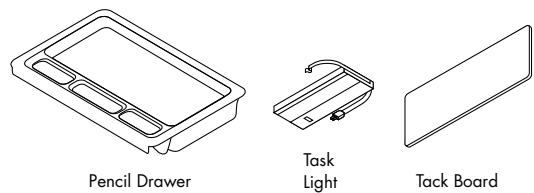

D^{DOANE}
K^{EYES}
A^{SSOCIATES, INC.}

P.O. Box 297 • Peru, IN 46970

1-800-342-5352 • Toll Free Fax 1-800-223-2352 • Local 1-765-473-5594 • Fax 1-765-473-5035

E-mail Address: dka@dka-online.com • Visit our Website: www.doanekeyes.com

Office Furniture Wholesalers

Since 1981